

# 0.9 cu. ft. Microwave Oven

MCD990W/MCD990B

Instruction Manual  
and Cooking Guide

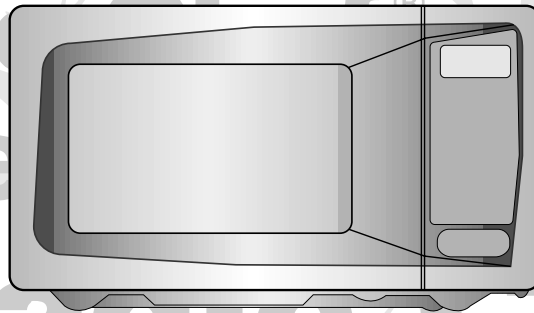

So Right at Home.

Before operating this oven, please read these instructions completely.

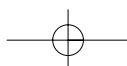

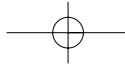

## PRECAUTIONS TO AVOID POSSIBLE EXPOSURE TO EXCESSIVE MICROWAVE ENERGY

- (a) **Do not attempt to operate this oven with the door open** since open-door operation can result in harmful exposure to microwave energy. It is important not to defeat or tamper with the safety interlocks.
- (b) **Do not place any object** between the oven front face and the door or allow soil or cleaner residue to accumulate on sealing surfaces.
- (c) **Do not operate the oven if it is damaged.** It is particularly important that the oven door close properly and that there is no damage to the: (1) door (bent), (2) hinges and latches (broken or loosened), (3) door seals and sealing surfaces.
- (d) The oven should not be adjusted or repaired by anyone except properly qualified service personnel.

## TABLE OF CONTENTS

PRECAUTIONS .....	1
IMPORTANT SAFETY INSTRUCTIONS .....	2
FEDERAL COMMUNICATIONS COMMISSION RADIO FREQUENCY INTERFERENCE STATEMENT (U.S.A ONLY) .....	3
GROUNDING INSTRUCTIONS .....	3
INSTALLATION .....	4
SPECIFICATIONS .....	5
FEATURES DIAGRAM .....	6
OPERATION PROCEDURE .....	8
CONTROLS .....	9
SETTING THE CLOCK .....	9
TIME DEFROSTING .....	9
WEIGHT DEFROSTING .....	10
COOKING IN ONE STAGE .....	11
COOKING IN TWO STAGES .....	11
KITCHEN TIMER MODE .....	12
SPEEDY COOK .....	13
ONE TOUCH COOKING .....	13
AUTO COOK .....	14
LESS, MORE .....	15
CHILD SAFETY LOCK .....	15
TO STOP THE OVEN WHILE THE OVEN IS OPERATION .....	15
MICROWAVE UTENSILS .....	16
COOKING GUIDE .....	17
CARE OF YOUR MICROWAVE OVEN .....	26
USE YOUR MICROWAVE OVEN SAFELY .....	27
BEFORE YOU CALL FOR SERVICE .....	28
QUESTIONS AND ANSWERS .....	28

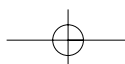

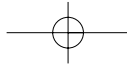

# IMPORTANT SAFETY INSTRUCTIONS

When using electrical appliances, basic safety precautions should be followed, including the following:

**WARNING-**To reduce the risk of burns, electric shock, fire, injury to persons or exposure to excessive microwave energy:

1. Read all instructions before using the appliance.
2. Read and follow the specific "PRECAUTIONS TO AVOID POSSIBLE EXPOSURE TO EXCESSIVE MICROWAVE ENERGY" found on page 1.
3. This appliance must be grounded. Connect only to properly grounded outlet. See "GROUNDING INSTRUCTIONS" found on page 3.
4. Install or locate this appliance only in accordance with the provided installation instructions.
5. Some products such as whole eggs and sealed containers - for example, closed glass jars-may explode and should not be heated in this oven.
6. Use this appliance only for its intended use as described in this manual. Do not use corrosive chemicals or vapors in this appliance. This type of oven is specifically designed to heat, cook, or dry food. It is not designed for industrial or laboratory use.
7. As with any appliance, close supervision is necessary when used by children.
8. Do not operate this appliance if it has a damaged cord or plug, if it is not working properly, or if it has been damaged or dropped.
9. This appliance should be serviced only by qualified service personnel. Contact nearest authorized service facility for examination, repair or adjustment.
10. Do not cover or block any openings on the appliance.
11. Do not store this appliance outdoors. Do not use this product near water — for example, near a kitchen sink, in a wet basement, or near a swimming pool, and the like.
12. Do not immerse cord or plug in water.
13. Keep cord away from heated surfaces.
14. Do not let cord hang over edge of table or counter.
15. Either:
  - a) When cleaning surfaces of door and oven that comes together on closing the door, use only mild, non-abrasive soaps or detergents applied with a sponge or soft cloth , or
  - b) When separate cleaning instructions are provided, See door surface cleaning instructions on (specific page or section to be included).
16. To reduce the risk of fire in the oven cavity:
  - a) Do not overcook food. Carefully attend appliance if paper, plastic, or other combustible materials are placed inside the oven to facilitate cooking.
  - b) Remove wire twist-ties from paper or plastic bags before placing bag in oven.
  - c) If materials inside the oven should ignite, keep oven door closed, turn oven off, and disconnect the power cord, or shut off power at the fuse or circuit breaker panel.
  - d) Do not use the cavity for storage purposes. Do not leave paper products, cooking utensils, or food in the cavity when not in use.
17. Do not use this microwave oven to heat corrosive chemicals (for example, sulfides and chlorides). Vapours from such corrosive chemicals may interact with the contact and springs of the safety interlock switches thereby rendering them inoperable.
18. Keep the waveguide cover clean at all times. Wipe the oven interior with a soft damp cloth after each use. If you leave grease or fat anywhere in the cavity it may overheat, smoke or even catch fire when next using the oven.
19. Never heat oil or fat for deep frying as you cannot control the temperature and doing so may lead to overheating and fire.

## SAVE THESE INSTRUCTIONS

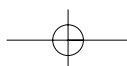

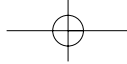

# FEDERAL COMMUNICATIONS COMMISSION RADIO FREQUENCY INTERFERENCE STATEMENT (U.S.A. ONLY)

**WARNING:**

This equipment generates and uses ISM frequency energy and if not installed and used properly, that is in strict accordance with the manufacturer's instructions, may cause interference to radio and television reception.

It has been type-tested and found to comply with limits for an ISM Equipment pursuant to part 18 of FCC Rules, which are designed to provide reasonable protection against such interference in a residential installation.

However, there is no guarantee that interference will not occur in a particular installation. If this equipment does cause interference to radio or television reception, which can be determined by turning the equipment off and on, the user is encouraged to try to correct the interference by one or more of the followings.

- Reorient the receiving antenna of radio or television.
- Relocate the Microwave oven with respect to the receiver.
- Move the microwave oven away from the receiver.
- Plug the microwave oven into a different outlet so that microwave oven and receiver are on different branch circuits.

THE MANUFACTURER is not responsible for any radio or TV interference caused by UNAUTHORIZED MODIFICATION to this microwave oven. It is the responsibility of the user to correct such interference.

## GROUNDING INSTRUCTIONS

This appliance must be grounded. In the event of an electrical short circuit, the grounding plug reduces the risk of electric shock by providing an escape wire for electric current. This appliance is equipped with a cord having a grounding wire with a grounding plug. The plug must be plugged into an outlet that is properly installed and grounded.

**WARNING:** Improper use of the grounding can result in a risk of electric shock.

Consult a qualified electrician or serviceman if the grounding instructions are not completely understood, or if doubt exists as to whether the appliance is properly grounded, and either :

- (1) If it is necessary to use an extension cord, use only a 3-wire extension cord that has a 3-blade grounding plug, and a 3-slot receptacle that will accept the plug on the appliance. The marked rating of the extension cord shall be equal to or greater than the electrical rating of the appliance. or
- (2) Do not use an extension cord, if the power supply cord is too short, have a qualified electrician or serviceman install an outlet near the appliance.

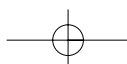

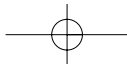

# INSTALLATION

## 1. Examine the oven after unpacking.

Check for damage such as a misaligned door, broken door or dent in the cavity. If any damage is visible, DO NOT INSTALL, and notify your dealer immediately.

## 2. Level, flat location.

Install the microwave oven on a level, flat surface.

## 3. Ventilation.

Do not block air vents. If they are blocked during operation, the oven may overheat and eventually cause a failure.

For proper ventilation, allow 3 inches of space between oven top, sides, rear and adjacent surfaces.

## 4. Away from radio and TV sets.

Poor television reception and radio interference may result if the oven is located close to a TV, radio, antenna, feeder, etc.

Place the oven as far from them as possible.

## 5. Away from heating appliances and water taps.

Keep the oven away from heat, steam or splashing liquids. These things can adversely affect oven wiring and contacts.

## 6. Power supply.

This microwave oven requires a power supply of approximately 12 Amperes, 120 Volts, 60Hz and a grounded outlet. A short power cord is provided to reduce the risk of the user becoming entangled in or tripping over a longer cord. Longer cord sets or extension cords are available and may be used if care is exercised.

If an extension cord is used, the marked electrical rating of the cord should be at least as great as the electrical rating of the oven.

The extension cord must be a grounding-type 3-wire cord. The longer cord should be arranged so it does not drape over the table top or counter where children can pull on it or trip over it.

7. The minimum height of free space necessary above the top surface of the oven is 100mm.

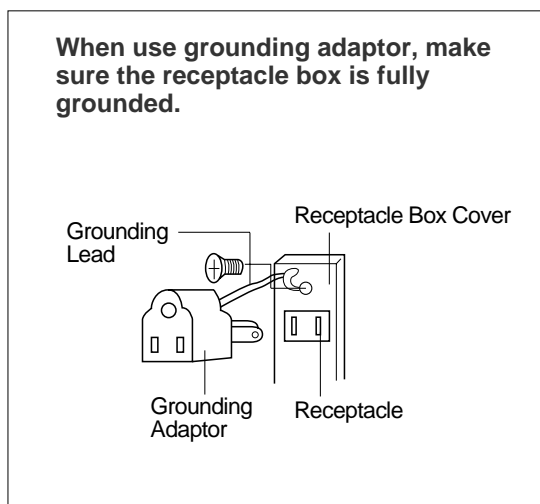
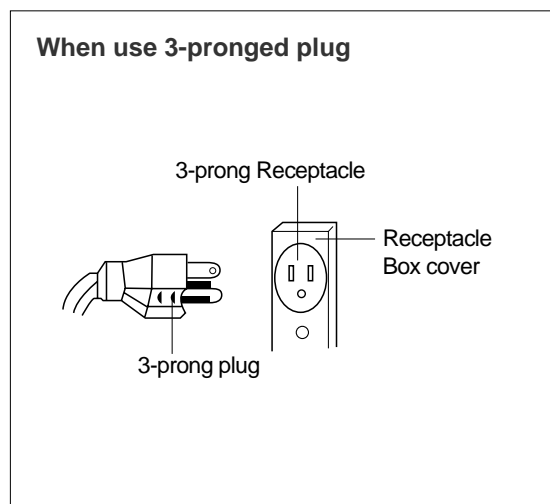

“THE CANADIAN ELECTRICAL CODE DOES NOT ALLOW THE USE OF THE GROUNDING ADAPTOR”

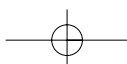



## SPECIFICATIONS

POWER SUPPLY		120V AC 60 Hz SINGLE PHASE WITH GROUNDING
MICROWAVE	POWER CONSUMPTION	1350 W
	OUTPUT POWER	900 W
	FREQUENCY	2450 MHz
OUTSIDE DIMENSIONS (W X H X D)		495 X 294 X 388 mm (19.5 X 11.6 X 15.3 in.)
CAVITY DIMENSIONS (W X H X D)		320 X 228 X 338 mm (12.6 X 9.0 X 13.3 in)
NET WEIGHT		APPROX. 14KG (30.9 lbs.)
TIMER		59 min. 99 sec.
POWER LEVELS		10 LEVELS

*\* Specifications are subject to change without notice.*

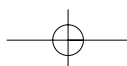
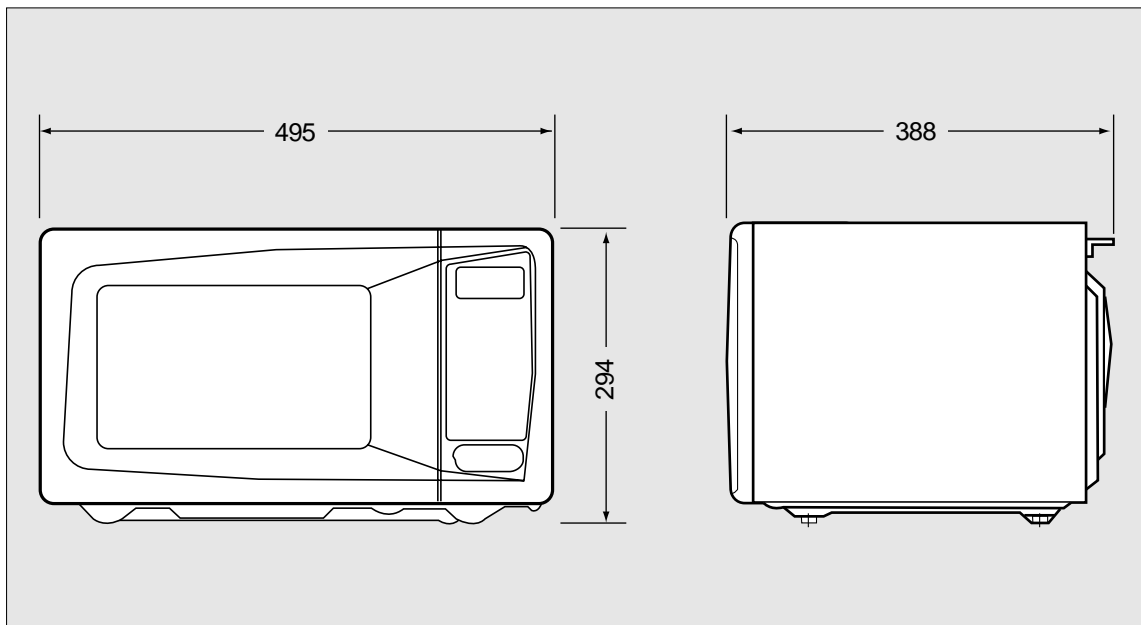

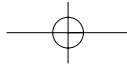

## FEATURES DIAGRAM

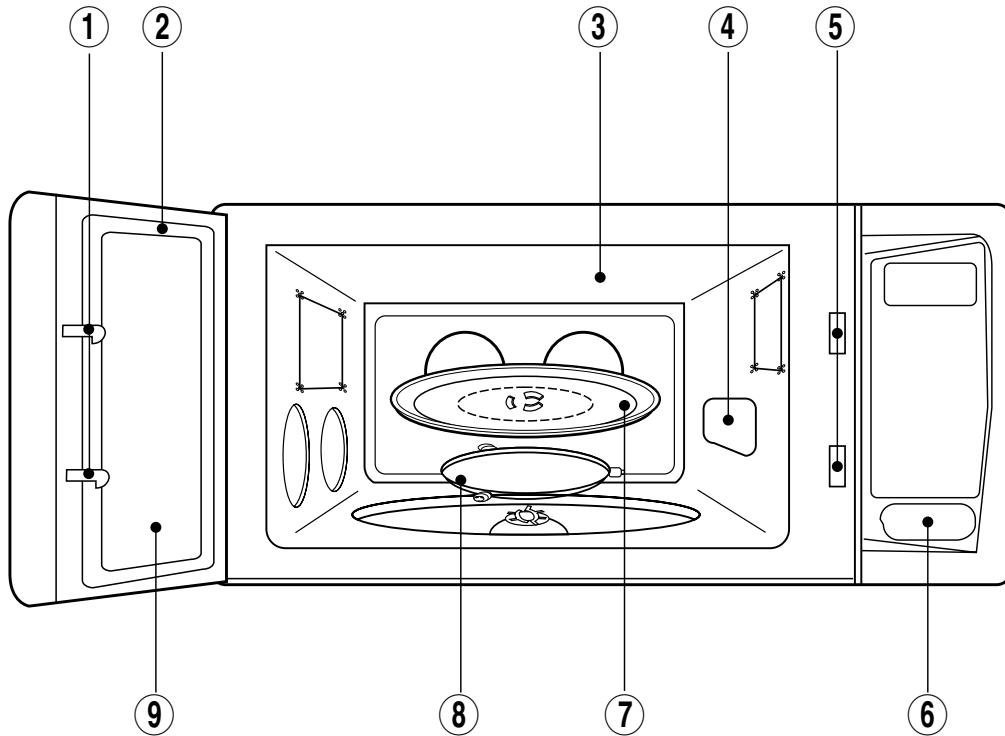

**1. Door latch**-When the door is closed it will automatically shut off. If the door is opened while the oven is operating, the magnetron will automatically shut off.

**2. Door seal**-The door seal maintains the microwave within the oven cavity and prevents microwave leakage.

**3. Oven cavity**

**4. Spatter shield**-Protects the microwave outlet from splashes of cooking foods.

**5. Safety interlock system**-Prevents the oven from operating while the door is opened.

**6. Door release button**-Pushing this button stops oven operation and opens the door.

**7. Glass cooking tray**-Made of special heat resistant glass. The tray must always be in proper position before operating. Do not cook food directly on the tray.

**8. Roller guide**-Supports the glass cooking tray.

**9. Door screen**-Allows viewing of food. The screen is designed so that light can pass through, but not the microwaves.

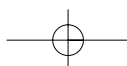

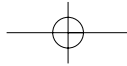

## FEATURES DIAGRAM (continued)

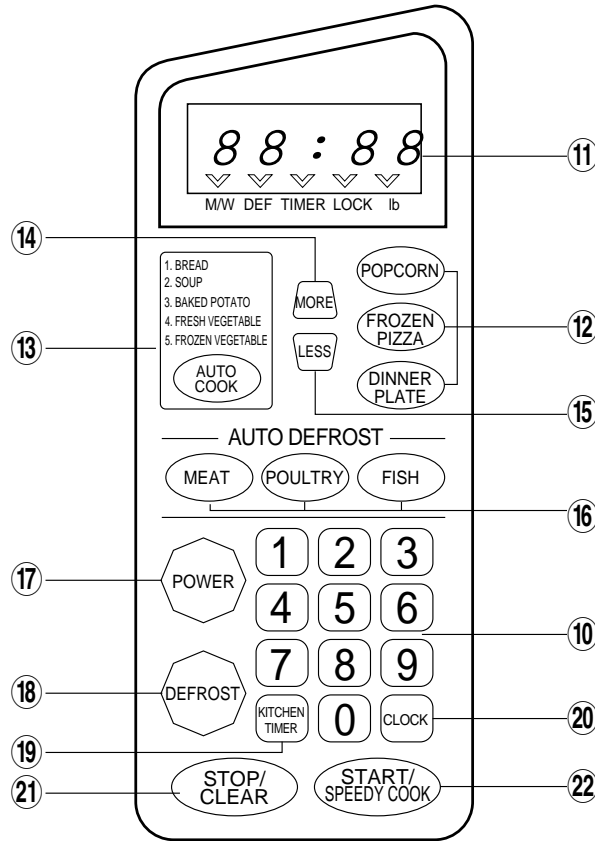

- 10. **Time set pad**-Used to set the cooking time and the present time.
- 11. **Display**-Cooking time, power level, indicators and present time are displayed.
- 12. **One touch**-Used to cook or reheat specific quantities of food.
- 13. **Auto Cook**-Used to cook or reheat.
- 14. **More**-Used to add time to cooking.
- 15. **Less**-Used to remove time from cooking.
- 16. **Auto Defrost**-Used to defrost foods.(for weight)
- 17. **Power**-Used to set power level.
- 18. **Defrost**-Used to defrost foods.(for time)
- 19. **Kitchen Timer**-Used as a minute timer, to delay the start of cooking, or to set a holding time after cooking.
- 20. **Clock**-Used to set clock.
- 21. **Stop/Clear**-Used to stop the oven operation or to delete the cooking data.
- 22. **Start/Speedy cook**-Used to start the oven and also used to set a reheat time.

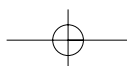



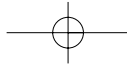

## OPERATION PROCEDURE

This section includes useful information about oven operation.

1. Plug power supply cord into a standard 3-pronged 12 Amp, 120V AC 60Hz power outlet.
  2. After placing the food in a suitable container, open the oven door and put it on the glass tray.  
The glass tray and roller guide must always be in place during cooking.
  3. Shut the door. Make sure that it is firmly closed.
- 1 The oven light is on only when the microwave oven is operating.
  - 2 The oven door can be opened at any time during operation by touching the door release button on the control panel. The oven will automatically shut off.
  - 3 Each time a pad is touched, a BEEP will sound to acknowledge the touch.
  - 4 The oven automatically cooks on full power unless set to a lower power level.
  - 5 The display will show “ : 0” when the oven is plugged in.
  - 6 Time clock returns to the present time when the cooking time ends.
  - 7 When the STOP/CLEAR pad is touched during the oven operation, the oven stops cooking and all information retained. To erase all information(except the present time), touch the STOP/CLEAR pad once more. If the oven door is opened during the oven operation, all information is retained.
  - 8 If the START pad is touched and the oven does not operate, check the area between the door and door seal for obstructions and make sure the door is closed securely. The oven will not start cooking until the door is completely closed or the program has been reset.

Make sure the oven is properly installed and plugged into the electrical outlet.

## WATTAGE OUTPUT CHART

- The power-level is set by pressing the POWER pad. The chart shows the display, the power level and the percentage of power.

Touch POWER pad	Power level (Display)	Approximate Percentage of Power
once	P-HI	100%
twice	P-90	90%
3 times	P-80	80%
4 times	P-70	70%
5 times	P-60	60%
6 times	P-50	50%
7 times	P-40	40%
8 times	P-30	30%
9 times	P-20	20%
10 times	P-10	10%
11 times	P-00	0%

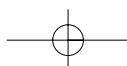

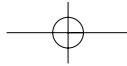

# CONTROLS

## SETTING THE CLOCK

When the oven is first plugged in, the display will flash “:0” and a tone will sound. If the AC power ever goes off, the display shows “ : 0” when the power comes back on.

CLOCK

1. Touch CLOCK pad.  
This is a 12 hour clock system.
2. Touch CLOCK pad once more.  
This is a 24 hour clock system.

**NOTE :** This oven has multiple clock systems. If you want 12 hour clock system, omit this step.

3. Enter the correct time of day by touching the numbers in sequence.

4. Touch CLOCK pad.

CLOCK

The display stops blinking, and the colon starts blinking. If you selected 12 hour clock system, this digital clock allows you to set from 1:00 to 12:59. If you selected 24 hour clock system, this digital clock allows you to set from 0:00 to 23:59.

**NOTE:** If you attempt to enter an incorrect time, the time will not be set and a error signal tone will sound. Touch the CLOCK pad and re-enter the time.

## TIME DEFROSTING

When DEFROST is selected, the automatic cycle divides the defrosting time into periods of alternating defrost and stand times by cycling on and off.

DEFROST

1. Touch DEFROST pad.
2. Touch number pads for the desired defrosting time.

The DEF indicator lights and “ : 0” is displayed.

The display will show what you touched.

**Note :** Your oven can be programmed for 59 minutes 99 seconds. ( 59 : 99 )

3. Touch START pad.

When you touch START pad, the DEF indicator starts blinking to show the oven is in the DEFROST mode. The display counts down the time to show you how much defrosting time is left in the DEFROST mode. The oven beeps during the defrosting cycle to signal that the food needs to be turned or rearranged. When the defrosting time ends, you will hear 3 beeps.

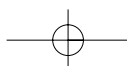

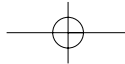

## WEIGHT DEFROSTING

AUTO DEFROST lets you easily defrost food by eliminating guesswork in determining defrosting time. Follow the steps below for easy defrosting.

- |             |  |  |
|-------------|--|--|
| <b>MEAT</b> | 1. Touch MEAT pad.   | The lb indicator light and “ 1.0 ” is displayed. |
|             | 2. Select the desired defrosting weight.<br>(Refer to the weight defrost chart below.) | The display will show what you touched.          |
|             | 3. Touch START pad.  | MEAT DEFROSTING begins.                          |

- |                |  |  |
|----------------|--|--|
| <b>POULTRY</b> | 1. Touch POULTRY pad.  | The lb indicator light and “ 1.5 ” is displayed. |
|                | 2. Select the desired defrosting weight.<br>(Refer to the weight defrost chart below.) | The display will show what you touched.          |
|                | 3. Touch START pad.  | POULTRY DEFROSTING begins.                       |

- |             |  |  |
|-------------|--|--|
| <b>FISH</b> | 1. Touch FISH pad.   | The lb indicator light and “ 0.5 ” is displayed. |
|             | 2. Select the desired defrosting weight.<br>(Refer to the weight defrost chart below.) | The display will show what you touched.          |
|             | 3. Touch START pad.  | FISH DEFROSTING begins.                          |

\* WEIGHT DEFROST CHART

Touch pad	MEAT	POULTRY	FISH
once	1.0 lb	1.5 lb	0.5 lb
twice	1.5 lb	2.0 lb	1.0 lb
3 times	2.0 lb	2.5 lb	1.5 lb
4 times	2.5 lb	3.0 lb	2.0 lb

The defrosting time is automatically determined by the weight selected. When you touch START pad, the lb indicator goes off and the DEF indicator blinks and the defrosting time counts down in the display window. The oven beeps during the defrosting cycle to signal that the food needs to be turned or rearranged. When the defrosting time ends, you will hear 3 beeps.

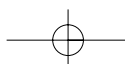

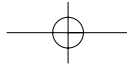

## COOKING IN ONE STAGE

**POWER**

X 6

1. Touch POWER pad.  
(Select the desired power level.)

The M/W indicator lights.  
The display will show what you touched.  
This example shows power level 5.

**Note :** If steps 1 and 2 are omitted,  
the oven will cook at full power.

2. Touch number pads for the cooking time.

The display will show what you touched.

**Note :** Your oven can be programmed for  
59 minutes 99 seconds. ( 59 : 99 )

3. Touch START pad.

When you touch START pad, the M/W indicator starts blinking to show the oven is cooking.  
The display counts down the time to show how much cooking time is left. When the cooking time ends, you will hear 3 beeps.

**NOTE:** Using lower power levels increases the cooking time which is recommended for foods such as cheese, milk and slow cooking of meats.

## COOKING IN TWO STAGES

All recipes require the frozen foods to be defrosted fully before cooking.  
This oven can be programmed to automatically defrost foods before cooking.

**DEFROST**

1. Touch DEFROST pad.

The DEF indicator lights and “ : 0” is displayed.

2. Touch number pads for the defrosting time you want.

The display will show what you touched.

**POWER**

X 6

3. Touch POWER pad.  
(Select the desired power level. )

The M/W indicator lights and “P-HI” is displayed.  
The display will show what you touched.  
This example shows power level 5.

4. Touch number pads for the desired cooking time.

The display will show what you touched.

5. Touch START pad.

When you touch START pad, the DEF and M/W indicators come on to confirm the power levels selected. The DEF indicator starts blinking to show you that the oven is in DEFROST mode.  
The display counts down the time remaining in DEFROST mode. When the oven beeps, turn over, break apart and/or redistribute the food. At the end of DEFROST mode, the oven will beep and start M/W cook. The DEF indicator goes off and the M/W indicator starts blinking. The display counts down the time remaining in M/W mode. When M/W cook ends, you will hear 3 beeps.

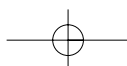

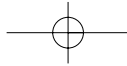

## KITCHEN TIMER MODE

Timer operates as a minute timer, can be set to delay cooking and used to set a holding time after cooking. However delay cooking can not be programmed for defrost. Timer operates without microwave energy.

### HOW TO USE AS A MINUTE TIMER

- |                          |   |   |
|--------------------------|---|---|
| <b>KITCHEN<br/>TIMER</b> | 1. Touch KITCHEN TIMER pad.                         | The TIMER indicator lights and “ : 0” is displayed. |
|                          | 2. Press the amount of time you want to count down. | The display will show what you touched.             |
|                          | 3. Touch START pad.                                 |   |

The TIMER indicator starts blinking and the display counts down the time remaining in KITCHEN TIMER mode. When KITCHEN TIMER mode ends, you will hear 3 beeps.

### HOW TO USE TO DELAY THE START OF COOKING

- |                          |  |   |
|--------------------------|--|---|
| <b>KITCHEN<br/>TIMER</b> | 1. Touch KITCHEN TIMER pad.  | The TIMER indicator lights and “ : 0” is displayed.                                 |
|                          | 2. Press the amount of time you want to delay.                             | The display will show what you touched.   |
|                          | 3. Program the desired power level and cooking time for food to be cooked. | The M/W indicator lights and the selected power level & cooking time are displayed. |
|                          | 4. Touch START pad.  |   |

When you touch START pad, the TIMER indicator starts blinking and the display counts down the time remaining in KITCHEN TIMER mode. When KITCHEN TIMER mode ends, the oven will beep. The TIMER indicator goes off and M/W indicator starts blinking. The display counts down the time remaining in M/W mode. When M/W cook ends, you will hear 3 beeps.

### HOW TO USE TO SET A HOLDING TIME

- |                          |  |  |
|--------------------------|--|--|
| <b>KITCHEN<br/>TIMER</b> | 1. Program the desired cooking time.                   | The M/W indicator lights and the selected time is displayed. |
|                          | 2. Touch KITCHEN TIMER pad.                            | The TIMER indicator lights and “ : 0” is displayed.          |
|                          | 3. Press the amount of time you want the oven to hold. | The display will show what you touched.                      |
|                          | 4. Touch START pad.                                    |  |

The M/W indicator starts blinking and the display counts down the time remaining in M/W mode. When the M/W cook ends, the oven will beep. The M/W indicator goes off and TIMER indicator starts blinking. The display counts down the time remaining in KITCHEN TIMER mode. When the KITCHEN TIMER mode ends, you will hear 3 beeps.

**Note :** Your oven can be programmed for 59 minutes 99 seconds. ( 59 : 99 )

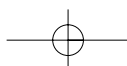

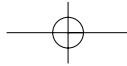

## SPEEDY COOK

SPEEDY COOK allows you to reheat for 30 seconds at 100% (full power) by simply touching the SPEEDY COOK pad.

By repeatedly touching the SPEEDY COOK pad, you can also extend reheating time to 5 minutes by 30 second increments.

**SPEEDY  
COOK**

1. Touch SPEEDY COOK pad.

When you touch SPEEDY COOK, ":30" is displayed.

After 1.5 seconds, the oven starts reheating.

## ONE TOUCH COOKING

One touch cook allows you to cook or reheat many of your favorite foods by touching just one pad.

To increase quantity, touch the chosen pad until number in display is same as the desired quantity to cook. (except for POPCORN)

**POPCORN**

1. Touch POPCORN pad once for 3.5 oz bag.

When you touch POPCORN pad once, "3.5" is displayed.

After 1.5 seconds, the display is changed into cooking time and the oven starts cooking.

- NOTE:**
1. Use prepackaged room-temperature microwave popcorn.
  2. Place bag in oven according to manufacturer's directions.
  3. Pop only one bag at a time.
  4. After popping, open bag carefully: popcorn and steam are extremely hot.
  5. Do not reheat unpopped kernels or reuse bag.
  6. Do not leave oven unattended while popping popcorn.

**CAUTION:** If prepackaged popcorn is of a different weight than the recommended weight, do not use the popcorn pad. Follow the manufacturer instruction.

**FROZEN  
PIZZA**

1. Touch FROZEN PIZZA pad once for 7 oz pizza or twice for 14 oz pizza.

When you touch FROZEN PIZZA pad once, "7" is displayed.

After 1.5 seconds, the display is changed into the cooking time and the oven starts cooking.

**\* FROZEN PIZZA \***

- 7 oz : Touch FROZEN PIZZA once.
- 14 oz : Touch FROZEN PIZZA twice within 1.5 seconds.

- NOTE:**
- 1 Use only one frozen pizza at a time
  2. Use only frozen pizza made for microwave ovens.
  3. If the cheese of frozen pizza does not melt sufficiently, cook a few seconds longer.
  4. Some brands of frozen pizza may require more or less cooking time.

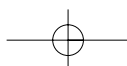

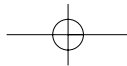

## ONE TOUCH COOKING (continued)

**DINNER PLATE**

1. Touch DINNER PLATE pad once for 12 oz of dinner plate or twice for 15 oz of dinner plate.

When you touch DINNER PLATE pad once, " 12 " is displayed. After 1.5 seconds, the display is changed into cooking time and the oven starts cooking.

**\* DINNER PLATE \***

- 12 oz : Touch DINNER PLATE once.
- 15 oz : Touch DINNER PLATE twice within 1.5 seconds.

## AUTO COOK

AUTO COOK allows you to cook or reheat many of your favorite foods by repeatedly touching auto cook pad.

**AUTO COOK**

1. Touch AUTO COOK pad.

When you touch AUTO COOK pad once, " AC-1 " is displayed. By repeatedly touching this pad, you can select other food category as shown in the chart below.

CATEGORY	FOOD	WEIGHT	TOUCH PAD
AC-1	BREAD	4slices(1.5-2 oz. each)	Touch AUTO COOK once.
AC-2	SOUP	12 oz.	Touch AUTO COOK twice
AC-3	BAKED POTATO	3potatoes(7-8 oz. each)	Touch AUTO COOK three times
AC-4	FRESH VEGETABLE	7 oz.	Touch AUTO COOK four times
AC-5	FROZEN VEGETABLE	7 oz. package	Touch AUTO COOK five times.

**START**

2. Touch START pad.

When you touch START pad, the display is changed into cooking time and the oven starts cooking.

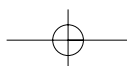

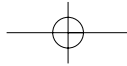

## LESS, MORE

---

To alter one touch cooking or cooking time whilst oven is in operation, use LESS or MORE.(except for defrosting)

Press LESS/MORE to decrease/increase the one touch cooking time in multiples of 10 seconds.

The overall one touch cooking time can be increased to a maximum of 59 minutes 50 seconds.

Press LESS/MORE to decrease/increase the cooking time in multiples of 1 minute.

The overall cooking time can be increased to a maximum of 59 minutes.

---

## CHILD SAFETY LOCK

---

The safety lock prevents unwanted oven operation such as by small children.

To set, press and hold STOP/CLEAR for 3 seconds, a beep sounds and LOCK indicator lights.

To cancel, press and hold STOP/CLEAR for 3 seconds, a beep sounds and LOCK indicator goes off.

---

## TO STOP THE OVEN WHILE THE OVEN IS OPERATING

---

1. Press STOP/CLEAR pad.

- You can restart the oven by touching START pad.
- Touch STOP/CLEAR once more to erase all instructions.
- You must enter in new instructions.

2. Open the door.

- You can restart the oven by closing the door and touching START.

**NOTE:** Oven stops operating when door is opened.

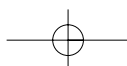



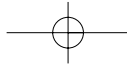

## UTENSIL TEST

Dishes that do not absorb microwave energy are best for microwave cooking. Look on the label to verify that particular cups, glasses, plates are indeed suitable, especially paper goods. If you are not sure, try this utensil test to check.

- Put the empty utensil in the microwave oven.
- Put one cup of water in a glass measure next to the empty utensil.
- Heat on HI for 1 minute.
- After 1 minute the water should be warm but the utensil should not. If the utensil is warm, it is not suitable for microwave cooking.

# MICROWAVE UTENSILS

## *Glass, Ceramic and China*

Ovenproof glass or ceramic baking dishes are the most used microwave utensils. Many of these items are readily available in most homes: glass measures, custard cups, mixing bowls, covered casseroles, pie plates and round or square cake dishes. Ovenproof dinnerware is usually safe to use in the microwave.

Do not heat or cook in glass jars or bottles.

Do not use dishes with silver, gold, platinum or other metal trim. Arcing may occur and/or the dish may break.

Do not use delicate or stemmed glassware. Although the glass may be transparent to microwave energy, heat from the food may cause the glassware to crack.

## *Plastics*

Plastic dishes, cups, mugs and bowls may be used in the oven for short periods of time. None of these should be used in the oven for prolonged periods because distortion and melting may occur.

Check manufacturer's recommendations concerning microwave safety.

Plastic wrap can be used to cover dishes in most recipes if the dish is deep enough to avoid plastic wrap touching the food. Always vent the wrap by folding back one corner to allow excess steam to escape.

Plastic cooking bags should be slit before cooking so excess steam can escape.

Do not use wire twist ties to close the bag. Wire twist ties can cause arcing which can damage the oven.

## *Paper*

Paper cups, wax paper, napkins, paper towels, and plates may be used for short cooking. Prolonged time in the oven can cause paper to burn. Do not use recycled paper products, such as brown paper bags.

They contain impurities which may cause arcing and damage the oven.

## *Metal*

Metal utensils should not be used in the oven. Metal reflects microwave energy so foods will not cook evenly. Metal can cause arcing and damage the oven.

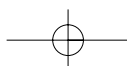



## COOKING GUIDE

### EGGS AND CHEESE

Eggs and cheese are delicate foods requiring care in microwave cooking. Piercing the yolks of eggs helps to release steam during cooking. Stirring egg mixtures frequently helps distribute the heat evenly. Because the microwave energy cooks so quickly, always check to see if the eggs are done to your satisfaction after the standing time. At this time, stir, rearrange or turn over. If needed, add additional time gradually. To cook only one egg, try a lower Power setting until you get satisfactory results.

Shredded soft cheeses and grated hard cheeses melt well if

stirred into a hot mixture. Cheese may not look melted so always stir before determining if cheese is melted enough. Sprinkle cheese over a hot casserole in a thicker layer at the edges. Microwave energy cooks from the outside in, so the outer edges will melt faster than the center.

For cheese melt sandwiches, heat filling where possible before adding it to the bread. Top each sandwich with a slice of cheese and cook on P-HI for about 15 to 20 seconds for one sandwich, about 30 seconds for two sandwiches and about 1 minute for four sandwiches or until cheese is melted.

#### HARD-COOKED EGGS

4 eggs

1. In a 4-cup glass measure, break eggs. Pierce each yolk twice with a fork.
2. Cover with wax paper. Press P-5. Cook for 3 minutes; stir to move cooked eggs from outer edges to the center - do not mix whites and yolks. Press P-5. Continue cooking for 3~4 minutes or until yolks are set; stir once during cooking. Let stand 3 minutes.

*4 servings*

#### CREAMY MACARONI AND CHEESE

- 1 cup (4 oz.) uncooked macaroni
- 1 quart hot water
- 1/2 teaspoon salt
- 2 tablespoons margarine or butter
- 1/4 cup chopped onion
- 2 tablespoons flour
- 1/2 teaspoon dry mustard
- 1/4 teaspoon salt
- 1/8 teaspoon pepper
- 1 1/4 cups milk
- 1 1/2 cups (6 oz.) shredded cheddar cheese

1. In a 2-quart glass casserole, combine macaroni, water and salt. Cook, uncovered, on P-HI for 7 minutes; stir once during cooking. Continue cooking on P-HI for 8 to 10 minutes or until macaroni is tender. Drain; rinse macaroni in a colander with hot water.
2. Heat margarine in same casserole for 30 to 40 seconds or until melted. Add onion. Cook, uncovered, on P-HI for 1 minute or until onion is tender.
3. Add flour, mustard, salt and pepper. Gradually stir in milk. Cook, uncovered, on P-HI for 7 to 8 minutes or until sauce boils and thickens; stir after each minute. Stir in cheese. Continue cooking on P-HI for 1 minute.
4. Add macaroni to cheese sauce; mix well. Cook, uncovered, on P-HI for 5 minutes or until heated thoroughly; stir once during cooking. Let stand 1 minute.

*4 servings*

#### CHEESE SPREAD

- 1 package (8 oz.) cream cheese
- 1/2 cup green onions
- 1 cup shredded carrots
- 2 teaspoons lime juice
- 1 cup (4 oz.) shredded Monterey Jack cheese
- 4 tablespoons toasted sliced almonds

1. In a 2-quart glass casserole put cream cheese, onions, carrots and lime juice.
2. Cook, uncovered, on P-HI for 4~5 minutes or until cream cheese is softened. Add Monterey Jack cheese; stir until well blended.
3. Spread on bread or crackers and top with almonds.

*4 servings*

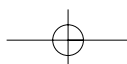

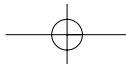

## VEGETABLES

Vegetables are favorite foods when cooked in the microwave. Because they cook for a shorter time and require less water than conventional cooking, vegetables cooked by microwave energy retain more vitamins than when cooked by other methods.

To cook better in the microwave, vegetables should be cut into evenly sized pieces. Baked potatoes, squash, or vegetables with skins can be pierced with a fork and arranged in a circle for the best cooking results. Uneven vegetables such as asparagus or broccoli, can be arranged in the dish alternating thick and thin ends. Stirring, rearranging, turning over and rotating are effective techniques to maximize the

way microwave energy cooks vegetables.

Consult the "COOKING FRESH VEGETABLES" chart on page 20 of this cookbook for preparation and stand time suggestions and for directions to use the automatic FRESH VEGETABLE pad. See this chart for suggested times for 4 ounce single serving of vegetables.

Use care in removing lid to prevent steam burn. Standing time is an important element in successful cooking because additional cooking will take place then. Make a decision about desired doneness after the standing time then add more time, if needed.

### LIGHT BAKED POTATOES

- 4 baking potatoes, about 8 oz. each salt and pepper
- 2 cups low fat cottage cheese
- 1/2 cup sliced green onions
- 2 tablespoons chopped fresh parsley
- Paprika

1. Scrub potatoes and pierce several times with a fork. Arrange in a circle on a microwave rack.
2. Cook, uncovered, on P-HI for 8 minutes. Turn each potato over. Continue cooking on P-HI for 7-9 minutes, or until potatoes are soft if squeezed lightly. Let stand for 5 minutes. Cut slit on top of potato and press ends to make opening for stuffing. Salt and pepper to taste.
3. Meanwhile in a small bowl, combine cottage cheese, green onions and parsley. Divide mixture evenly among potatoes. Arrange stuffed potatoes in a circle on a serving platter. Sprinkle with paprika

*4 servings*

### SPINACH AND ARTICHOKE DIP

- 2 tablespoons chopped onion
- 1 medium red bell pepper, chopped (about 1 cup)
- 1 clove garlic, minced
- 1 package (10 oz.) frozen chopped spinach, defrosted
- 1 can (14 oz.) artichoke hearts, drained and chopped
- 1 package (8 oz.) cream cheese, softened
- 1 tablespoon lemon juice
- 1 teaspoon seasoned salt
- 1/4 teaspoon hot pepper sauce

1. In a 2-quart casserole, combine onion, bell pepper, and garlic.
2. Cook, uncovered, on P-HI for 3 minutes or until red pepper is crisp-tender; drain spinach and squeeze dry. Add spinach, artichokes hearts, cream cheese, lemon juice, salt and hot pepper sauce to red pepper mixture; stir to mix well. Serve warm.

*3 cups*

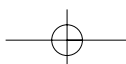

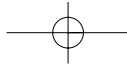

## BROCCOLI AND CAULIFLOWER SALAD

- 1 cup broccoli florets
- 1 cup cauliflower florets
- 1/2 cup mayonnaise
- 1 to 2 teaspoons prepared mustard
- 1/2 teaspoon dried basil, crushed
- 1/4 teaspoon salt

1. In a 2-quart glass casserole, combine broccoli and cauliflower
2. Cover with lid or vented plastic wrap. Cook on P-HI for 3 to 4 minutes or until vegetables are tender-crisp; cool.
3. In a small bowl, combine mayonnaise, mustard, basil and salt. Pour over vegetables; toss gently to mix.

*4 servings*

## HOT JALAPENO SALAD

- 1 1/2 cups shredded cabbage
- 1/2 cup shredded carrots
- 1/4 cup medium green bell pepper, cut into 1-inch long thin strips
- 1/2 cup sliced cherry tomatoes
- 1/4 cup sliced green onion
- 2 tablespoons fresh, chopped cilantro
- 1/4 cup Monterey Jack jalapeno cheese, cut into 1 inch cubes
- 3 oz. cream cheese, softened
- 1 tablespoon white wine vinegar

1. In a 1/2-quart glass casserole, combine cabbage, carrots, bell pepper, tomatoes, green onion and cilantro. Set aside.
2. In a 4-cup glass measure, combine cheese cubes, creamed cheese and vinegar; blend well.
3. Press P-3. Cook, uncovered, for 4 minutes; stir twice during cooking. Continue cooking on P-HI for 1 minute; stir. Let stand for 2 minutes; stir until smooth. Pour cheese over vegetable mixture; toss gently to mix.
4. Cover with vented plastic wrap. Cook on P-HI for about 3 minutes or until mixture is heated thoroughly; stir once during cooking. Let stand for 2 minutes.

*4 servings*

## CHINESE STIR-FRY

- 2 tablespoons vegetable oil
- 1 clove garlic, minced
- 1 teaspoon fresh ginger
- 1/4 cup sliced green onion
- 4 medium (or 12 small) carrots, peeled and sliced
- 1/2 cup green bell pepper, cut into strips
- 1 package (6 oz.) frozen pea pods
- 1 cup fresh bean sprouts
- 2 tablespoons soy sauce
- 1 cup sliced mushrooms

1. In a 2-quart glass casserole, combine oil, garlic, ginger and onion. Cook, uncovered, on P-HI for 1 minute. Add carrots and green pepper.
2. Cover with lid or vented plastic wrap. Continue cooking on P-HI for 3 minutes.
3. Add pea pods, bean sprouts and soy sauce, stirring to mix; cover. Continue cooking on P-HI for 3 minutes. Stir in mushrooms. Continue cooking on P-HI for 3 minutes; stir once. Let stand, covered, for 3 minutes.

*4 servings*

## WILTED SPINACH SALAD

- 6 slices bacon
- 1/4 cup bacon drippings or oil
- 1/2 pound fresh spinach leaves
- 2 tablespoons sugar
- 2 tablespoons vinegar

1. Arrange bacon on microwave rack. Cover with microwave paper towel. Cook on P-HI for 4 to 5 minutes or until bacon is crisp, rearrange once during cooking. Pour 1/4 cup bacon drippings into a 2-cup glass measure; discard any remaining drippings. Drain and crumble bacon.
2. Wash spinach leaves, pat dry and put in a serving bowl. Add sugar and vinegar to reserved drippings; stir to mix well.
3. Cook, uncovered, on P-HI for 1 minute or until boiling. Carefully stir, then pour over fresh spinach. Serve immediately.

*4 servings*

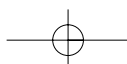

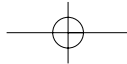

## VEGETARIAN CHILI

- 1/2 cup celery, chopped
- 1 small onion, chopped (about 1/2 cup)
- 1/2 medium green bell pepper, chopped (1/4 cup)
- 1 tablespoon chili powder
- 1 teaspoon salt
- 1/4 teaspoon crushed red pepper flakes
- 1/8 teaspoon freshly ground black pepper
- 1 can (15 1/2 oz.) mild chili beans in sauce, undrained
- 1 can (15 oz.) Great Northern beans, drained
- 1 can (15 oz.) chick peas (garbanzo beans), drained
- 2 cans (about 15 oz. each) diced tomatoes, undrained

1. In a 2-quart glass casserole, combine celery, onion and green pepper.
2. Cover with lid or vented plastic wrap. Cook on P-HI for 3 to 4 minutes or until vegetables are tender. Add chili powder, salt, red pepper and black pepper to vegetables; mix well. Stir in chili beans with sauce, Great Northern beans, chick peas and tomatoes.
3. Continue cooking on P-HI for 18 to 20 minutes or until heated thoroughly; stir once during cooking. Stir before serving.

**4 servings**

## GLAZED BABY CARROTS

- 1 pound peeled baby carrots
- 2 tablespoons butter
- 1 tablespoon brown sugar
- 1/2 teaspoon cinnamon
- Dash ground cloves

1. In a 1 1/2-quart glass casserole, combine carrots, butter, brown sugar, cinnamon and cloves.
2. Cover with lid or vented plastic wrap. Cook on P-HI for 11~12 minutes or until carrots are tender; stir every 2 minutes during cooking. Let stand for 3 minutes.

**4 servings**

## CANDIED SWEET POTATOES

- 2 medium sweet potatoes (about 1 1/4 lbs.)
- 2 medium tart baking apples
- 1/4 cup apple cider or juice
- 1/4 cup firmly packed brown sugar
- 1 teaspoon cinnamon
- 2 tablespoon margarine or butter
- 1/4 cup coarsely chopped pecans or walnuts

1. Wash and peel sweet potatoes and apples; slice in 1/4-inch slices. Layer slices in a 1 1/2-quart glass casserole. Pour juice over the top. In a small bowl, combine brown sugar and cinnamon; sprinkle on top; cut margarine into small pieces; place evenly on top. Sprinkle with nuts.
2. Cover with lid or vented plastic wrap. Cook on P-HI for 13~16 minutes or until potatoes are tender.
3. Let stand for 3 minutes.

**4 servings**

## GREEN BEANS IN CREAM SAUCE

- 1 package (10 oz.) frozen French-style green beans
- 1 can (10 3/4 oz.) condensed cream of celery soup, undiluted
- 1/2 cup sliced fresh mushrooms
- 1/4 cup milk
- 1/2 teaspoon soy sauce
- 1 can (2.8 oz.) French fried onions

1. In a 2-quart glass casserole, place green beans. Cover with lid or vented plastic wrap. Cook on P-HI for 4 to 5 minutes or until heated. Let stand, covered, for 5 minutes; drain. Stir in mushrooms, soup, milk and soy sauce.
2. Continue cooking on P-HI for 5 minutes or until heated thoroughly. Add half onions; stir. Continue cooking on P-HI for 5 minutes. Sprinkle with remaining onions. Cook, uncovered, for 1 minute. Let stand, uncovered, for 2 minutes before serving.

**4 servings**

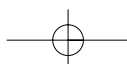

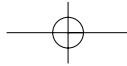

## FISH AND SEAFOOD

Delicate, tender fish is the result when cooked in the microwave. Because it is moist cooking, the finished fish and seafood, if cooked for the appropriate time, will be opaque and flake with a fork with no signs of dryness.

Because fish is unevenly shaped, the arrangement is critical to success. To arrange several fillets in a deep glass pie plate, put thicker edges to the outside and thinner edges to the inside. Try to create a circle for best results, even overlap thin ends where necessary to achieve overall even thickness.

Single items may do better if the thin ends are shielded with a foil. Some rules apply to the use of foil—Never cover more than one-third of any item; do not let the foil pieces touch

each other or the sides of the microwave oven, and be sure that all ends are tucked under and lie flat to the food. Cover with wax paper to prevent spattering.

Seafood cooks very quickly in the microwave—about 3 to 4 minutes per pound. Wait for stand time, then proceed carefully with extra time, to finish cooking without overcooking. Cooked seafood will be opaque and firm, but not tough.

Frozen fish and seafood are convenient to keep on hand. See the "FISH-AUTO DEFROSTING" chart on page 11 of this cookbook for defrosting details.

### CRUMB-COATED BAKED FISH

- 1 cup seasoned bread crumbs
- 1 teaspoon dried parsley
- 1 teaspoon lemon pepper
- 1/2 cup plain yogurt
- 1 pound fresh or thawed frozen fish fillets

1. In a deep glass pie plate, combine bread crumbs, parsley and lemon pepper. Coat fish with yogurt; then coat with crumb mixture.
2. Arrange fish in an 8-inch square glass baking dish with thick edges to the outside. Cover with a wax paper with the vented corner. Cook on P-HI for 8~10 minutes or until fish flakes easily when tested with a fork.

**4 servings**

### FISH ROLL-UPS

- 1 package (10 oz.) frozen chopped spinach
- 1 teaspoon instant minced onion
- 2 teaspoons lemon juice
- 1/4 cup soft cream cheese
- 4 fresh fish fillets, 1/2-inch thick (about 3/4 lb.)
- 1/2 teaspoon paprika

1. Open spinach package. Place package on a paper towel. Cook on P-HI for 8 minutes. Drain spinach and place in a mixing bowl. Stir in onion and lemon juice.
2. Spread cream cheese evenly on fish fillets. Divide spinach evenly; spread over cream cheese. Roll up fish; secure with wooden picks. Place fish in a deep glass pie plate; sprinkle with paprika.
3. Cover with vented plastic wrap. Cook on P-HI for 6 to 8 minutes or until fish flakes easily when tested with a fork. Remove wooden picks.

**4 servings**

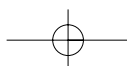

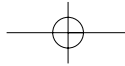

### FISH FILLET AMANDINE

- 1/4 cup margarine or butter, divided
- 1/2 cup slivered almonds
- 1 teaspoon almond liqueur, optional
- 1 pound fresh or thawed frozen fish fillets
- 1 tablespoon lemon juice

1. In a 2-cup glass measure, heat 2 tablespoons margarine on P-HI for 1 minute or until melted. Add almonds. Cook, uncovered, on P-HI for 2 minutes or until almonds are lightly toasted; stir twice during cooking. Stir in liqueur if desired.
  2. In an 8-inch square glass baking dish, heat 2 tablespoons margarine on P-HI for 1 minute. Place fish in baking dish, turning to coat both sides in margarine. Sprinkle with lemon juice. Cover with vented plastic wrap. Cook on P-HI for 7-8 minutes or until fish flakes easily when tested with a fork.
  3. Top with toasted almonds.
- 4 servings**

### WINE-POACHED FISH

- 1 cup dry white wine
- 1/4 teaspoon rosemary leaves, crushed
- 1/4 teaspoon salt
- 1/8 teaspoon white pepper
- 1 pound fresh or defrosted fish fillets
- 1/2 lemon, thinly sliced

1. In an 8-inch square glass baking dish, combine wine, rosemary, salt and pepper. Add fish, thick edges to the outside. Top with lemon slices.
  2. Cover with vented plastic wrap. Cook on P-HI for 5 to 7 minutes or until fish flakes easily when tested with a fork.
- 4 servings**

## COOKING FISH AND SEAFOOD

1. Arrange fish and seafood on a microwave rack (fillets, steaks, lobster) or in an appropriate glass casserole (scallops).
2. Cover with wax paper and set on glass turntable in a microwave.
3. Calculate cooking time by multiplying weight of the fish or seafood by the time recommended per pound.
4. The microwave will cook on P-HI unless another power level is entered at the time of cooking. To choose another power level, and begin cooking, press Power continuously to program the recommended power level. Press the number pad to program the calculated time. Press START.
5. Check progress about halfway through the cooking time; turn over, rearrange or shield, as needed.
6. Within several minutes before the end of cooking check fish or seafood to determine if time needs adjusting. Wait until the stand time before making the final decision.

ITEM	POWER	COOK	STAND TIME
Fish Fillets--or-- Fish Steaks	P-HI	5-7 minutes per pound	2 minutes
Shrimp--or-- Scallops	P-HI	3-4 minutes per pound	2 minutes
Lobster Tail	P-HI	6-8 minutes per pound	2 minutes

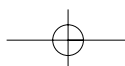

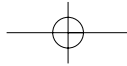

## POULTRY

Juicy and moist describes poultry cooked by microwave energy. It is a superior method for cooking chicken to be used in casseroles, salads, or to have for sandwiches. See Poached Chicken recipe.

Arrangement is very important with poultry and its uneven shapes. Try to arrange pieces in a circular pattern wherever possible for the most even defrosting or cooking. The rounded part of the drumstick should go at the outer edge, for example, while the thinner end goes to the middle of the dish. Continue with other pieces until the overall layer is fairly even. Cover with wax paper to prevent spattering.

Poultry defrosts well with our AUTO DEFROST feature

(see page 15). Be sure that all poultry is completely defrosted before cooking. Check for doneness after stand time is over.

Remember that more cooking will take place during standing time. Poultry must be cooked to an internal temperature of 160°F for boneless pieces, to 170°F for bone-in pieces and to 185°F for whole birds.

Poultry is done when the meat is no longer pink and the juices are the colour of chicken broth with no traces of pink. Be sure to check for these signs by cutting into the inner thigh. You may also check for the internal temperature with an instant-read thermometer. Occasionally the bones will show red spots, but this does not affect the doneness.

### POACHED CHICKEN

- 2 bone-in chicken breast halves (about 1 lb.)
- 1 celery stalk, cut up
- 1 medium carrot, cut up
- 1 small onion, chopped (about 1/2 cup)
- 1 cup chicken broth

1. In a 2-quart casserole, place chicken breast halves. Add celery, carrot, onion and chicken broth.
2. Cover with lid or vented plastic wrap. Cook on P-HI for 12 to 15 minutes or until chicken is no longer pink and juices run clear; turn chicken over halfway through cooking. Let stand 5 minutes.

*4 servings*

### BBQ CHICKEN

- 1 broiler-fryer chicken, cut in serving pieces (2 1/2 to 3 lbs.)
- 1/2 cup catsup
- 2 tablespoons brown sugar
- 2 tablespoons vinegar
- 1 teaspoon Worcestershire sauce
- 1 teaspoon prepared mustard
- 1/2 teaspoon salt
- 1/4 teaspoon pepper

1. Rinse chicken and pat dry with paper towels. On a microwave rack, arrange chicken pieces skin side down in a single layer with thickest parts to outside.
2. In a 2-cup glass measure, combine catsup, brown sugar, vinegar, Worcestershire, mustard, salt and pepper. Reserve 1/2 cup of sauce.
3. Brush half of remaining barbecue sauce over chicken. Cover with wax paper. Cook on P-HI for 10 minutes. Rearrange and turn over chicken; brush with remaining sauce. Continue cooking on P-HI for 8 to 10 minutes or until chicken is no longer pink and juices run clear. Let stand 3 minutes. Serve with reserved sauce.

*4 servings*

### MEXICAN CHICKEN RICE CASSEROLE

- 1 pound boneless, skinless chicken breasts, cut into strips
- 1/2 teaspoon cumin
- 1/4 teaspoon salt
- 1 tablespoon margarine or butter
- 1 clove garlic, minced
- 1 cup mild or medium salsa
- 1 cup chicken broth
- 3/4 cup quick cooking rice
- 1 cup corn chips, crushed to 1/2 cup
- 1/2 cup (2 oz.) shredded Monterey Jack or cheddar cheese

1. Season chicken with cumin and salt. In a 1 1/2-quart casserole, heat margarine on P-HI for 50 to 60 seconds or until melted; stir in chicken and garlic.
2. Cook, uncovered, on P-HI for 7~9 minutes or until chicken is no longer pink; stir three times during cooking. Stir in salsa, chicken broth and rice.
3. Cover with lid or vented plastic wrap. Cook on P-HI for 5~6 minutes or until boiling. Let stand, covered, until liquid is absorbed, about 4 minutes. Stir; sprinkle with crushed corn chips and cheese.
4. Cook, uncovered, on P-HI for 2~3 minutes or until cheese is melted.

*4 servings*

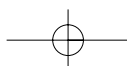



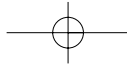

## MEATS

Tender cuts of meat do well in the microwave, especially when cooked at lower power levels. Be sure meat is fully defrosted before cooking. Consult the meat cooking charts (pages 30-32) for details.

The exact time to cook each piece of meat will depend on the shape of the meat, the weight, the starting temperature of the meat and the desired doneness. Our timings assume the meat is taken from the proper storage (refrigerated). The lower number in the time range reflects time suggested for medium

meat; the higher number for well done. It is always possible to add time if needed, so it is best to start with the lower number for calculating the time.

Stand time after cooking is an important aspect of microwave cooking since more cooking will take place then. The residual heat in the food will equalize and finish the cooking process. Always check for doneness after the stand time.

### MEATBALLS

- 1 egg, beaten
- 1/3 cup milk
- 1/4 cup quick cooking oats, uncooked
- 1/4 cup dry bread crumbs
- 1 pound lean ground meat (combination of beef and pork or turkey)
- 1 medium onion, chopped
- 1 tablespoon dried parsley flakes
- 1 teaspoon salt
- 1/4 teaspoon freshly ground black pepper

1. In a small bowl, combine egg, milk, oats and bread crumbs; let stand 2 minutes. In mixing bowl, combine ground meat, onion, parsley, salt and pepper. Add egg mixture; mix well. Form meat mixture into 24 meatballs.
2. In a 2-quart casserole, place meatballs in a single layer. Cover with wax paper. Cook on P-HI for 12 to 14 minutes or until meat is no longer pink; turn meatballs twice during cooking. Drain meatballs; let stand for 3 minutes before serving.

*4 servings*

### PEPPER STEAK

- 1 pound beef steak (flank, round or sirloin)
- 2 tablespoons white wine vinegar
- 1 tablespoon water
- 1/4 cup soy sauce
- 1 teaspoon garlic/salt
- 1/2 teaspoon sugar
- 1/4 teaspoon ground ginger
- 1 large green bell pepper, cut into strips
- 1 medium onion, sliced
- 2 medium tomatoes, peeled and quartered
- 1 cup fresh mushrooms, sliced
- 1 cup brown gravy
- Hot cooked rice

1. Slice beef across the grain into strips. In a 2-quart glass casserole, combine vinegar, water, soy sauce, garlic, salt, sugar and ground ginger. Add meat to mixture; coat each piece. Cover with lid or plastic wrap and marinate in refrigerator for 30 minutes.
2. Remove bowl from refrigerator. Stir in green bell pepper and onion; cover. Press Power pad continuously by P-8. Cook, uncovered, for 5 minutes. Stir in tomatoes and mushrooms.
3. Cover with lid or vented plastic wrap. Press Power pad by P-9. Continue cooking for 10 minutes or until meat is tender; stir once during cooking. Add brown gravy to meat mixture; stir.
4. Continue cooking on P-HI for 4 to 5 minutes or until meat mixture is thoroughly heated. Let stand for 3 minutes.

*4 servings*

#### TIP

Thin pieces of meat are no longer pink when fully cooked. Take meat from the microwave while slightly pink to prevent overcooking during standing time.

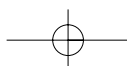



## PORK SAUSAGE CASSEROLE

- 1 medium red onion
- 3 green apples, seeded and cubed
- 2 tablespoons margarine or butter
- 1 package (12 oz.) bulk pork sausage, cooked, drained and crumbled
- 1 sweet potato (about 8 oz.) cooked, peeled and cubed
- 1 jar (12 oz.) pork gravy

1. Peel onion and cut in half. Slice it thinly. In a 2-quart glass casserole, combine onion, apples and margarine.
2. Cover with lid or vented plastic wrap. Cook on P-HI for 5 minutes, or until onions and apples are tender. Stir in sausage, sweet potato and gravy.
3. Continue cooking on P-HI for 8-10 minutes or until heated thoroughly.

**4 servings**

## SWEET 'N' SOUR PORK

- 1 pound boneless pork cubes
- 3/4 cup apricot preserves
- 2 tablespoons mustard
- 2 tablespoons apple cider vinegar
- 2 tablespoons light soy sauce
- 1 can (8 oz.) sliced water chestnuts, drained
- 1 can (8 oz.) pineapple chunks, drained
- 1 can (11 oz.) mandarin orange segments, drained
- 2 pounds frozen pea pods, cooked and drained
- 2 cups cooked rice
- 1/4 cup sliced almonds

1. In a 2-quart glass casserole, place pork cubes. Cover with wax paper. Cook on P-HI for 8 minutes; stir once during cooking to rearrange cooked cubes. Drain pork.
2. Stir in apricot preserves, mustard, vinegar, soy sauce, water chestnuts, pineapple, oranges and pea pods. Cook, uncovered, on P-HI for 4 minutes or until heated thoroughly. Serve over cooked rice and top with sliced almonds.

**4 servings**

## BEEF, PEPPERS AND PASTA

- 3 cups bell pepper chunks (red, yellow and green)
- 1 cup onion, sliced
- 2 tablespoons margarine or butter
- 1 1/2 cups chopped cooked beef
- 2 cups cooked elbow macaroni, drained
- 1 can (14.5 oz.) seasoned diced tomatoes, undrained
- 1 jar (14 oz.) traditional-style pasta sauce

1. In a 2-quart glass casserole, combine bell peppers, onions and margarine. Cover with lid or vented plastic wrap. Cook on P-HI for 6 to 7 minutes or until vegetables are tender.
2. Stir in beef, macaroni, tomatoes and pasta sauce. Continue cooking on P-HI for 6 to 7 minutes or until heated thoroughly.

**4 servings**

## LAMB SHEPHERD CASSEROLE

- 2 cups sliced celery
- 1 cup sliced carrots
- 2 tablespoons margarine or butter
- 2 cups cubed cooked potatoes
- 2 cups cubed cooked lamb
- 1 can (15 1/4 oz.) whole kernel corn, drained
- 1 can (10 3/4 oz.) cream of celery soup, undiluted
- 1 jar (12 oz.) onion gravy

1. In a 2-quart glass casserole, combine celery, carrots and margarine. Cover with lid or vented plastic wrap. Cook on P-HI for 6 minutes or until vegetables are tender.
2. Stir in potatoes, lamb, corn, soup and gravy. Continue cooking on P-HI for 8 to 10 minutes or until heated thoroughly.

**4 servings**

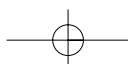

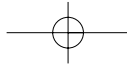

## CARE OF YOUR MICROWAVE OVEN

- 1 Turn the oven off before cleaning.
- 2 Keep the inside of the oven clean. When food spatters or spilled liquids adhere to oven walls, wipe with a damp cloth. Mild detergent may be used if the oven gets very dirty. The use of harsh detergent or abrasives is not recommended.
- 3 The outside oven surface should be cleaned with soap and water, rinsed and dried with a soft cloth. To prevent damage to the operating parts inside the oven, water should not be allowed to seep into the ventilation openings.
- 4 If the Control Panel becomes wet, clean with a soft, dry cloth. Do not use harsh detergents or abrasives on Control Panel.
- 5 If steam accumulates inside or around the outside of the oven door, wipe with a soft cloth. This may occur when the microwave oven is operated under high humidity conditions and in no way indicates malfunction of the unit.
- 6 It is occasionally necessary to remove the glass tray for cleaning. Wash the tray in warm sudsy water or in a dishwasher.
- 7 The roller guide and oven cavity floor should be cleaned regularly to avoid excessive noise. Simply wipe the bottom surface of the oven with mild detergent water or window cleaner and dry. The roller guide may be washed in mild sudsy water.

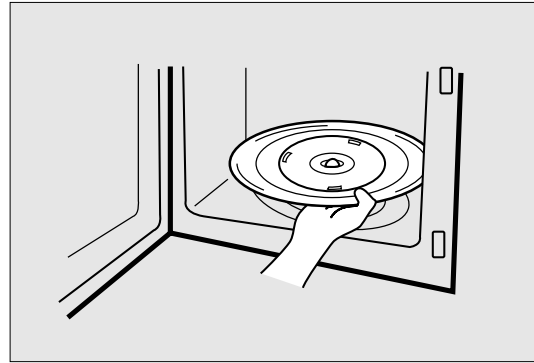

### ROLLER GUIDE

- 1 The ROLLER GUIDE and oven floor should be cleaned frequently to prevent excessive noise.
- 2 The ROLLER GUIDE MUST ALWAYS be used for cooking together with the Glass Tray.

### GLASS TRAY

- 1 DO NOT operate the oven without the Glass Tray in place.
- 2 DO NOT use any other Glass Tray with this oven.
- 3 If Glass Tray is hot, ALLOW TO COOL before cleaning or placing it in water.
- 4 DO NOT cook directly on the Glass Tray.

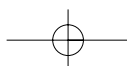
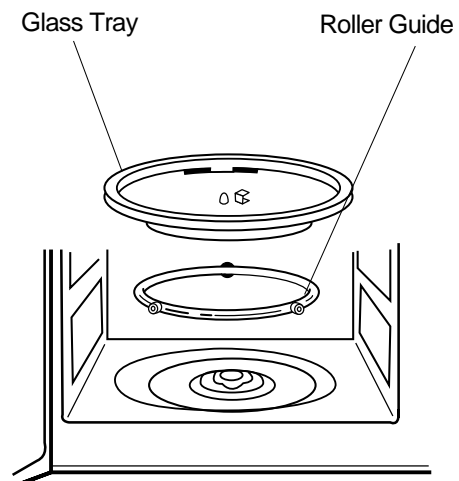

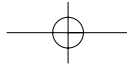

# USE YOUR MICROWAVE OVEN SAFELY

## *General Use*

Do not attempt to defeat or tamper with safety interlocks.

Do not place any object between the oven front frame and the door or allow residue to build up on sealing surfaces. Wipe with a mild detergent, rinse and dry. Never use abrasive powders or pads.

Do not subject the oven door to strain or weight such as a child hanging on an open door.

This could cause the oven to fall forward resulting in injury to you and damage to the oven.

Do not operate the oven if door seals or sealing surfaces are damaged; or if door is bent; or if hinges are loose or broken.

Do not operate the oven empty. This will damage the oven.

Do not attempt to dry clothes, newspapers or other materials in the oven. They may catch on fire.

Do not use recycled paper products as they may contain impurities which may cause sparks or fires.

Do not hit or strike the control panel with hard objects. This can damage the oven.

## *Food*

Never use your microwave oven for home canning. The oven is not designed for proper home canning. Improperly canned food may spoil and be dangerous to consume.

Always use the minimum recipe cooking time. It is better to undercook rather than overcook foods. Undercooked foods can be returned to the oven for more cooking. If food is overcooked, nothing can be done.

Heat small quantities of food or foods with low moisture carefully. These can quickly dry out, burn or catch on fire.

Do not heat eggs in the shell. Pressure may build up and eggs can explode.

Potatoes, apples, egg yolks and sausages are examples of food with non-porous skins. These must be pierced before cooking to prevent bursting.

Do not attempt to deep fat fry in your microwave oven.

Always stir liquids before heating. Heated liquids can erupt, if not mixed with air.

Do not leave the oven unattended while popping corn.

Do not pop corn in a paper bag unless it is the commercially prepared Microwave Popcorn product. The kernels can overheat and ignite a brown paper bag.

Do not put packaged Microwave Popcorn bags directly on the oven tray. Place the package on a microwave safe glass or ceramic plate to avoid overheating and cracking the oven tray.

Do not exceed the Microwave Popcorn manufacturers' suggested popping time. Longer popping does not yield more popcorn but it can result in scorch, burn or fire. Remember, the Popcorn bag and tray can be too hot to handle. Remove with caution and use pot holders.

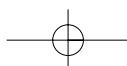



## BEFORE YOU CALL FOR SERVICE

Refer to the following checklist, you may prevent an unnecessary service call.

\* The oven doesn't work :

1. Check that the power cord is securely plugged in.
2. Check that the door is firmly closed.
3. Check that the cooking time is set.
4. Check for a blown circuit fuse or tripped main circuit breaker in your house.

\* Sparking in the cavity;

1. Check utensils. Metal containers or dishes with metal trim should not be used.
2. Check that metal skewers or foil does not touch the interior walls.

If there is still a problem, contact the service station.

A list of these stations is included in the oven.

**DO NOT ATTEMPT TO SERVICE THE OVEN YOURSELF !**

## QUESTIONS AND ANSWERS

\* **Q** : I accidentally ran my microwave oven without any food in it. Is it damaged?

**A** : Running the oven empty for a short time will not damage the oven. However, it is not recommended.

\* **Q** : Can the oven be used with the glass tray or roller guide removed?

**A** : No. Both the glass tray and roller guide must always be used in the oven before cooking.

\* **Q** : Can I open the door when the oven is operating?

**A** : The door can be opened anytime during the cooking operation. Then microwave energy will be instantly switched off and the time setting will maintain until the door is closed and START is touched.

\* **Q** : Why do I have moisture in my microwave oven after cooking?

**A** : The moisture on the side of your microwave oven is normal. It is caused by steam from cooking food hitting the cool oven surface.

\* **Q** : Dose microwave energy pass through the viewing screen in the door?

**A** : No. The metal screen bounces back the energy to the oven cavity. The holes are made to allow light to pass through. They do not let microwave energy pass through.

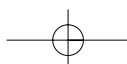

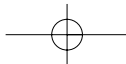

Please send products and other correspondence to:  
Magic Chef  
455 E. State Pkwy., Suite 104  
Schaumburg, IL 60173



First-Class  
Postage  
Required  
Post Office will  
not deliver  
without proper  
postage.

**EHG01-01**



**PO BOX 174264  
DENVER CO 80217-4264**

Please detach before mailing



# PRODUCT REGISTRATION



## RETURN THIS CARD NOW FOR:

- **Warranty Confirmation**

With the information you provide, we can confirm the date of purchase, model and serial number of your product. This confirmation is of benefit to you if the original proof of purchase is lost. We will keep the information in our files for up to ten (10) years.

- **\$100,000 Give Away III**

We'll automatically enter you for a chance to win \$5,000, \$25,000, or even \$50,000!

### IMPORTANT:

Please Complete and Return.  
You could win up to \$50,000 in the  
\$100,000 Give away III! See inside...

**Magic Chef®**





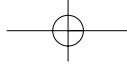

# Warranty



## Magic Chef®

DAEWOO ELECTRONICS CORPORATION OF AMERICA warrants each new electronic product manufactured by it to be free from defective material and workmanship and agrees to remedy any such defect or to furnish a new part (at the Company's option) in exchange for any part of any unit of its manufacture which under normal installation, use, and service disclosed such defect, provided the unit is delivered by the owner to us or to our authorized distributor from whom purchased or authorized service station, intact, for our examination with all transportation charges prepaid to our factory, To establish and receive warranty service at our factory or authorized service facilities, proof of purchase/dated sales invoice is required

Return authorization must be obtained before any merchandise is returned to the factory.

This warranty does not extend to any of our electronic products which have been subjected to misuse, neglect, accident, incorrect wiring not our own, improper installation, unauthorized modification, or to use in violation of instructions furnished by us, nor units which have been repaired or altered outside of our factory, nor to cases where the serial number thereof has been removed, defaced, or changed

This warranty is in lieu of all warranties expressed or implied and no representative or person is authorized to assume for us any other liability in connection with the sale of our electronic products.

**Over-the-counter** exchange for units that are initially defective.

"Initially defective" is described as when the dealer opens the unit and finds that it is inoperative or a customer opens a new unit and finds that it is inoperable. This unit may be returned to the factory by the dealer for exchange. Under no circumstances will the customer be permitted to return the defective unit directly to the factory.

Exchange must be directly with the dealer.

Model	Parts	Labor	Magnetron
MCD990W/MCD990B	1 year	1 year	8 years

**For Service or Assistance, please call : 1-800-553-4355**

